



Congratulations on your selection to purchase an Arnott Air Suspension System. We at Arnott Air Suspension Systems are proud to offer a high quality product at the industry's most competitive pricing. Thank you for your confidence in us and our product.

Proper installation is essential to experience and appreciate the benefits of this system. Please take a moment to review these installation instructions before you begin to install this system on your vehicle.

It is equally important to be aware of all necessary safety measures while installing your new Air Ride System. This includes proper lifting and immobilizing of the vehicle and isolation of any stored energy to prevent personal injury or property damage.

“Engineered to Ride, Built to last”



VERY IMPORTANT!!

THESE AIR SPRINGS CONTAIN A SOLENOID VALVE. ONCE INFLATED; ONLY THE “MERCEDES DAS STAR” DIAGNOSTIC COMPUTER CAN DEFLATE THE AIR SPRINGS.



FIGURE 10-0

The Arnott Inc. (A-2536/A-2559) Air Spring replaces the OEM Air Spring; eliminating the need for an air reservoir. (FIGURE 10-0)



WARNING: *The air suspension system is under pressure (up to 10 bar, or 150 lbf/in) verify pressure has been relieved and disconnect power to the air ride system prior to dis-assembly. Do not allow dirt or grease to enter the system. Always wear standard protective hand, ear, and eye protection when servicing the air suspension system.*

Kit contains:

PARTS LIST			
P/N	QTY		DESCRIPTION
A-2536/A-2559	2		REAR AIR SPRING



General information:

- * Not to be stored below 5 °F (-15 °C) and above 122 °F (50 °C).*
- *Avoid damage to air lines and cables.*
- *Removal and installation is only to be performed by full qualified personnel.*
- *Use car manufacturer's diagnostic software. *CAUTION: Damage to the vehicle and shock assembly can be incurred if work is carried out in a manner other than specified in the instructions or in a different sequence.*



REAR SHOCK REMOVAL:

NOTE: REAR AIR SPRING REMOVAL/INSTALLATION IS FOR BOTH THE REAR RIGHT AND LEFT AIR SPRING.



The ignition must remain switched off during the shock removal and replacement.

- 1.1 SET STEERING TO STRAIGHT AHEAD.
- 1.2 REMOVE POSITIVE BATTERY TERMINAL BEFORE STARTING WORK



Use lifting platform (hoist) that is capable of raising the body separately from the wheels, lift body at the lifting points prescribed by the vehicle manufacturer.

Vehicle slippage can cause danger to life and limb.

- 3.0 RAISE VEHICLE.
- 4.0 REMOVE REAR TIRE(S). (FIGURE 10-1)

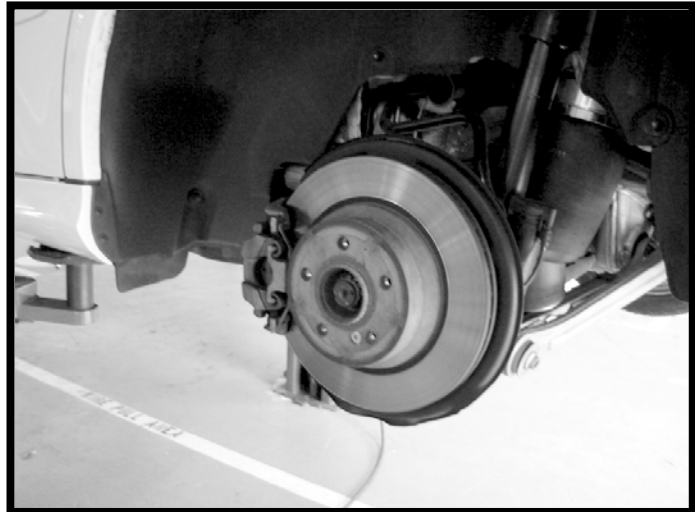

FIGURE 10-1



NOTE: *Air pressure! Release slowly and allow pressure to escape*

5.0 DISCONNECT THE AIRLINE AND THE MOUNTING NUTS FROM THE AIR BLOCK, AND MARK AIR LINES. (Figure 10-2).

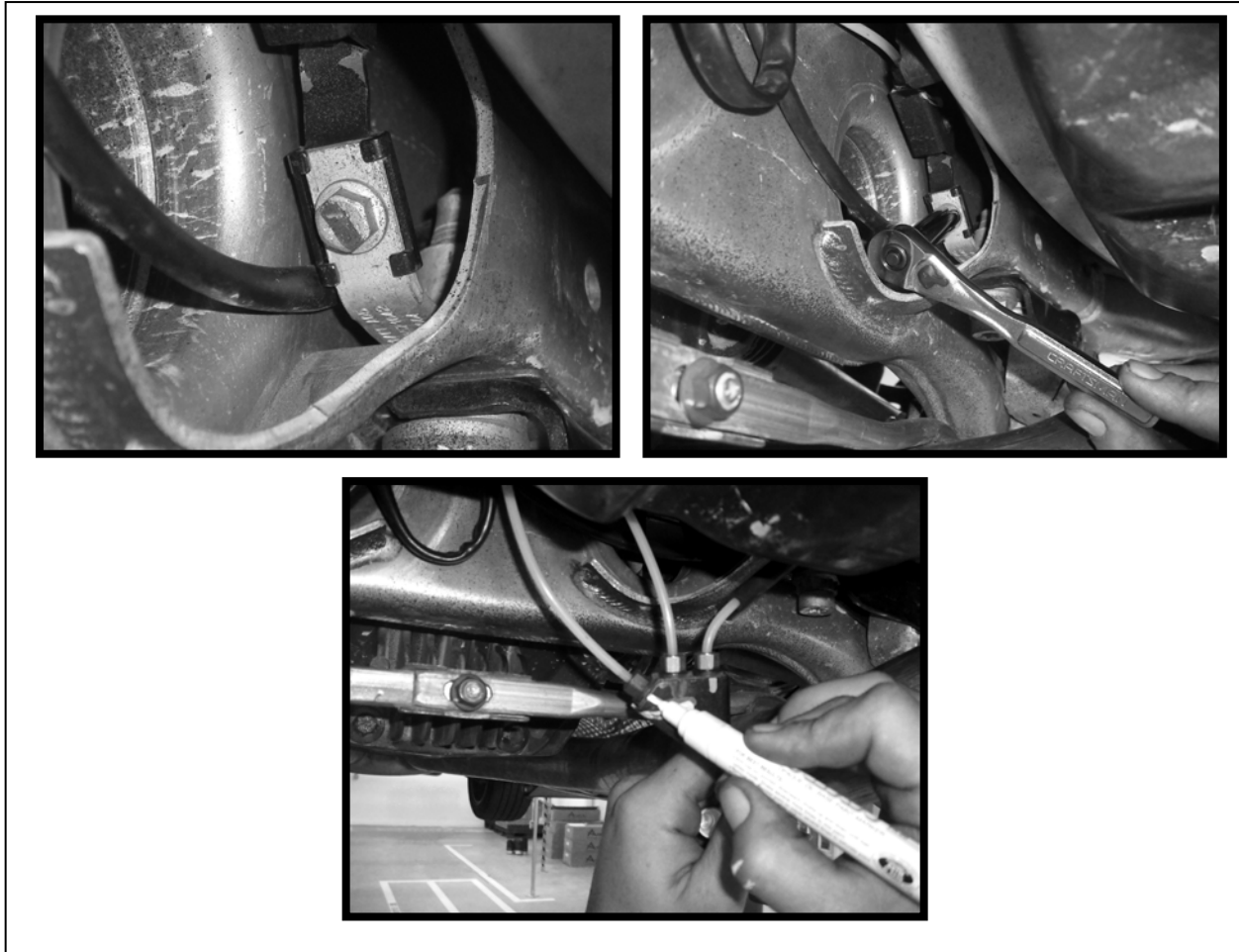

FIGURE 10-2



6.0 AFTER AIR LINES ARE REMOVED, UNPLUG AIR SPRING VALVE WIRING.
(FIGURE 10-3)

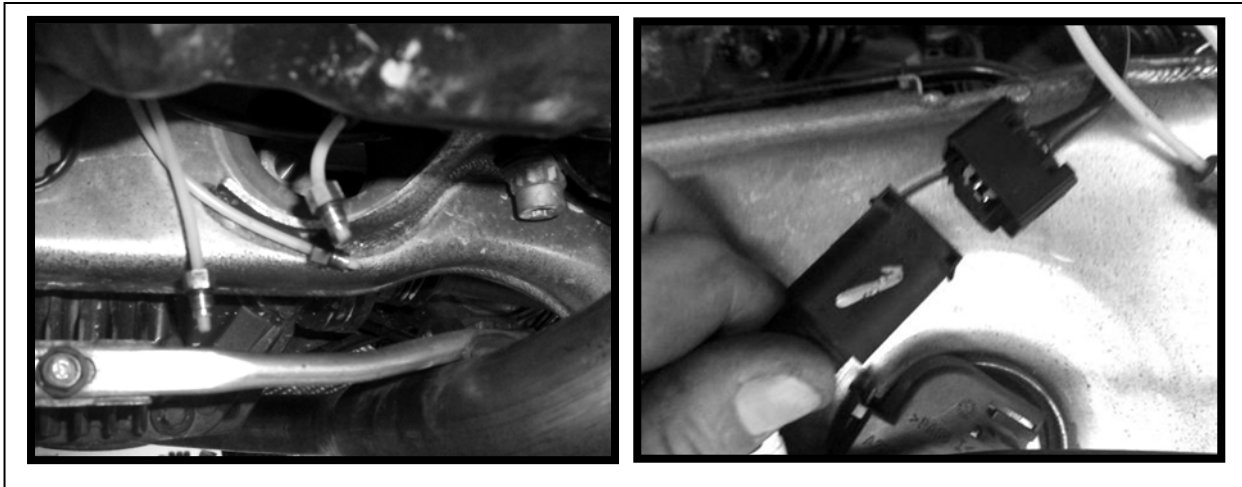

FIGURE 10-3

7.0 REMOVE BOLTS FROM FENDER WELL. (FIGURE 10-4)

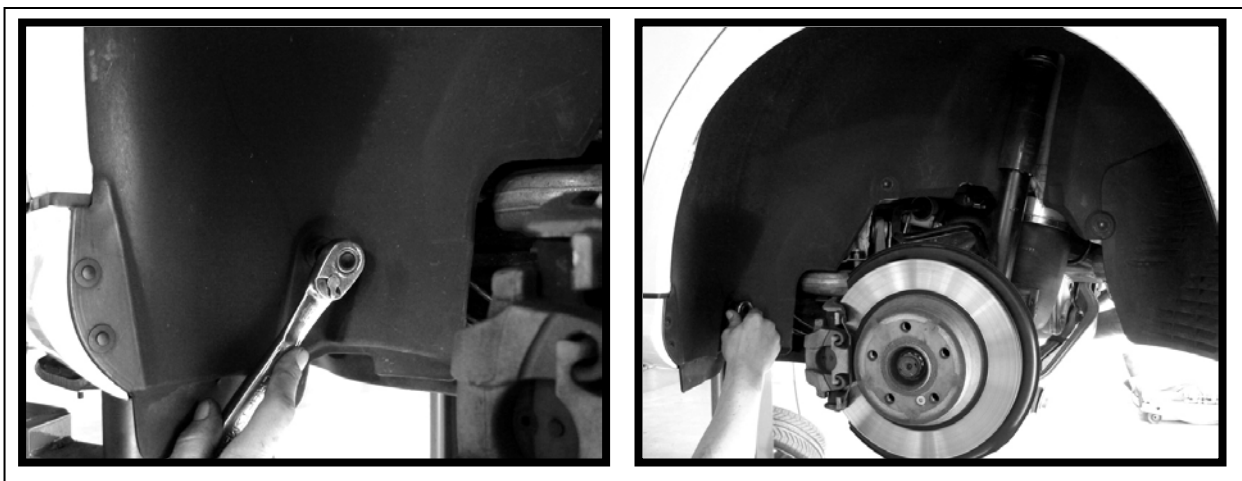

FIGURE 10-4



8.0 REMOVE PUSH PINS FROM FENDER WELL, EXPOSING SENSOR
JUNCTION BLOCK. (FIGURE 10-5)

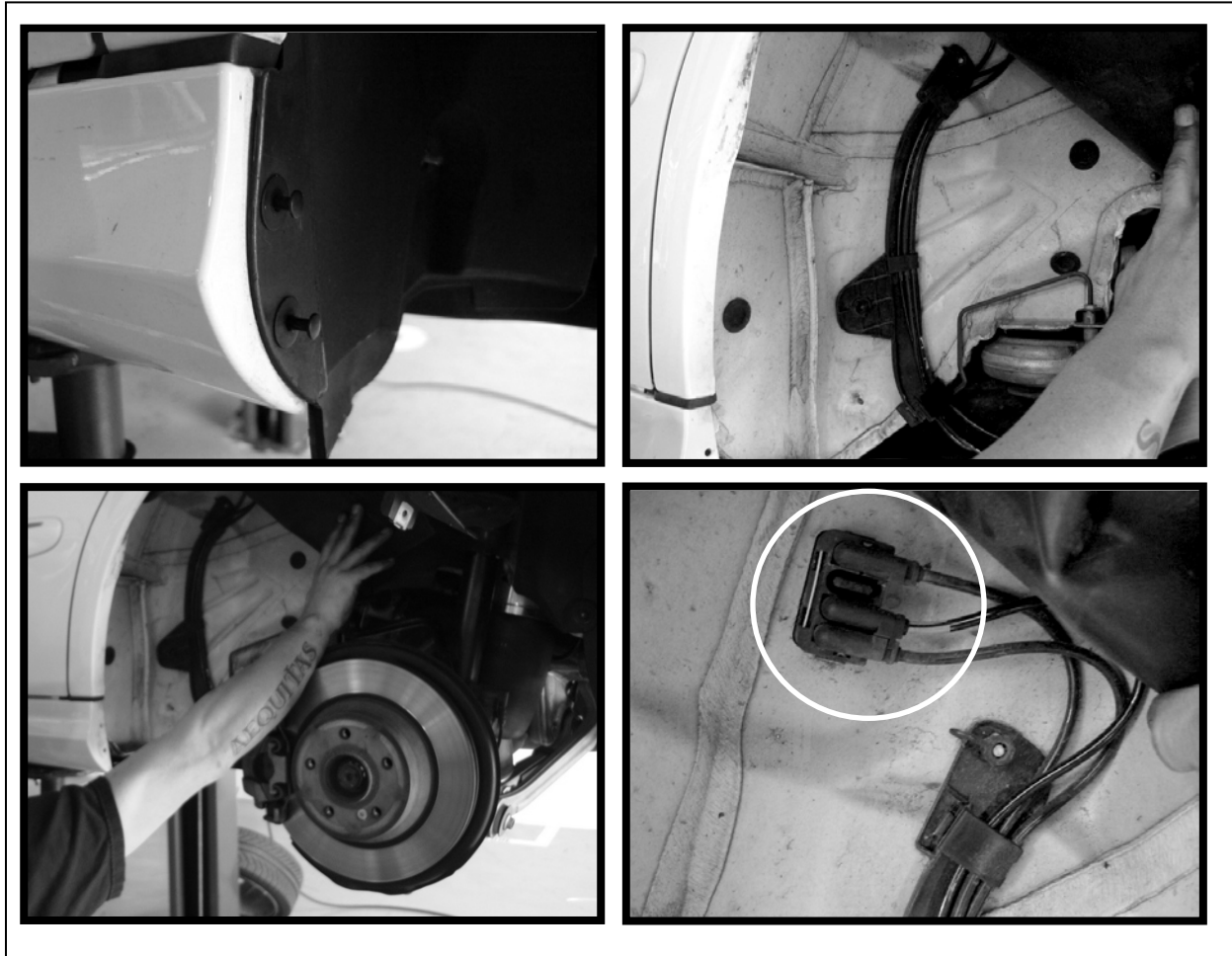

FIGURE 10-5



9.0 MARK CONNETIONS TO ENSURE PROPER PLACEMENT ON REASSEMBLY,
REMOVE RETAINING CLIP AND UNPLUG SENSOR LINES.
(FIGURE 10-6)

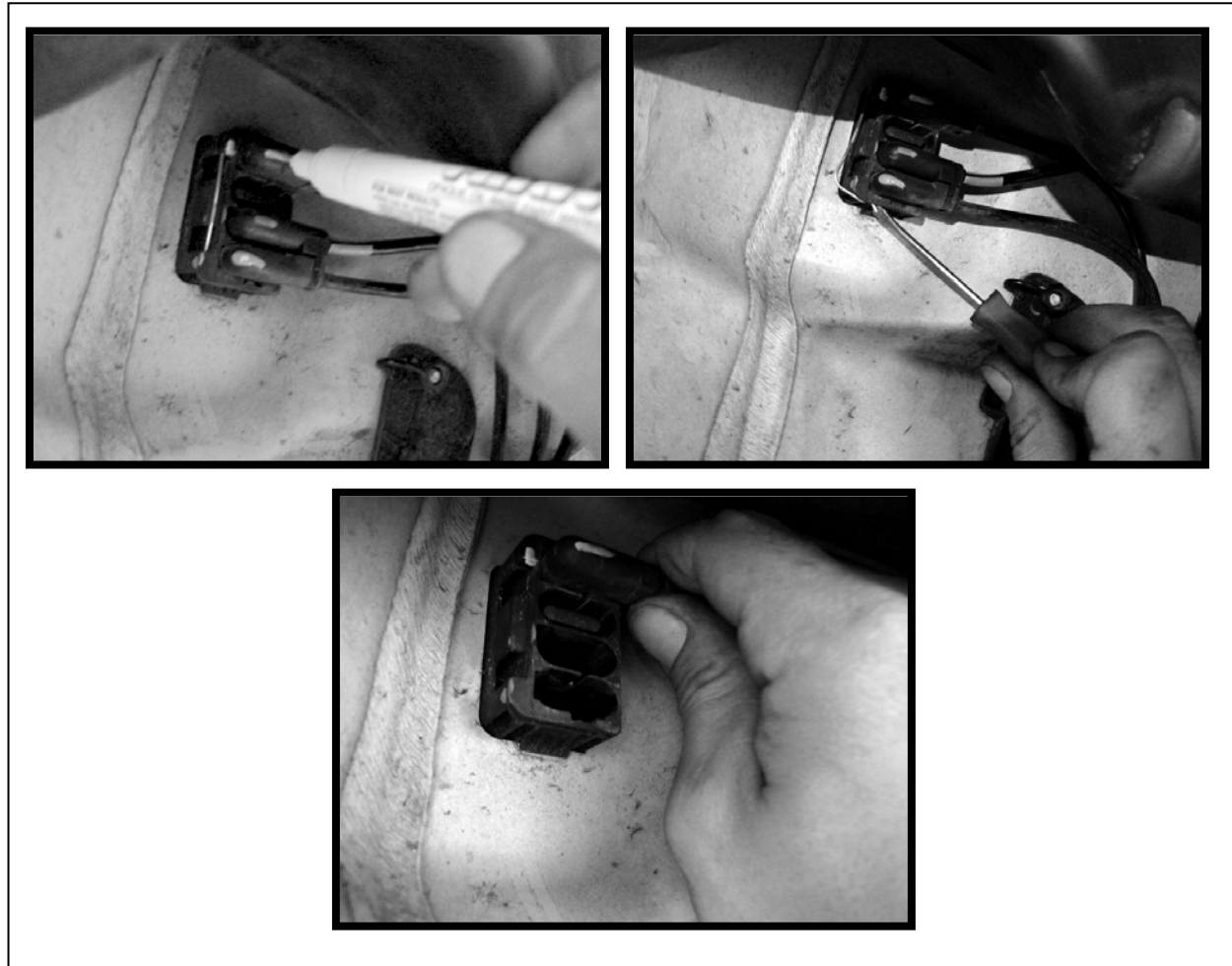

FIGURE 10-6



10.0 REMOVE SENSOR LINES FROM BRACKETS. (FIGURE 10-7)

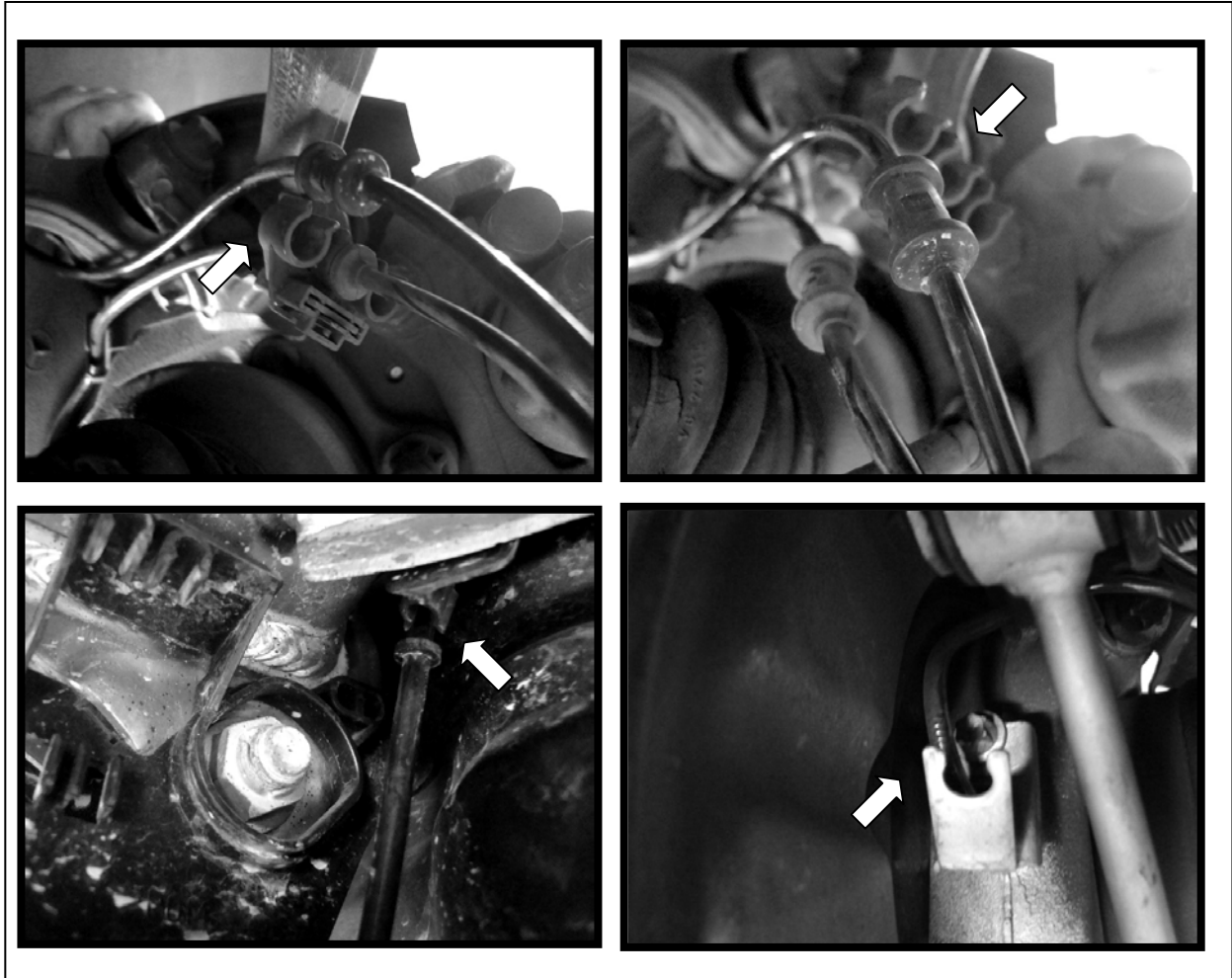

FIGURE 10-7



11.0 REMOVE AIR SPRING BOLTS FROM THE LOWER CONTROL ARM.
(FIGURE 10-8)



FIGURE 10-8

12.0 REMOVE THE LOWER SHOCK BOLTS. (FIGURE 10-9)



FIGURE 10-9



13.0 SUPPORT EXHAUST, AND LOOSEN AND REMOVE EXHAUST FLANGE BOLTS. (FIGURE 10-10)

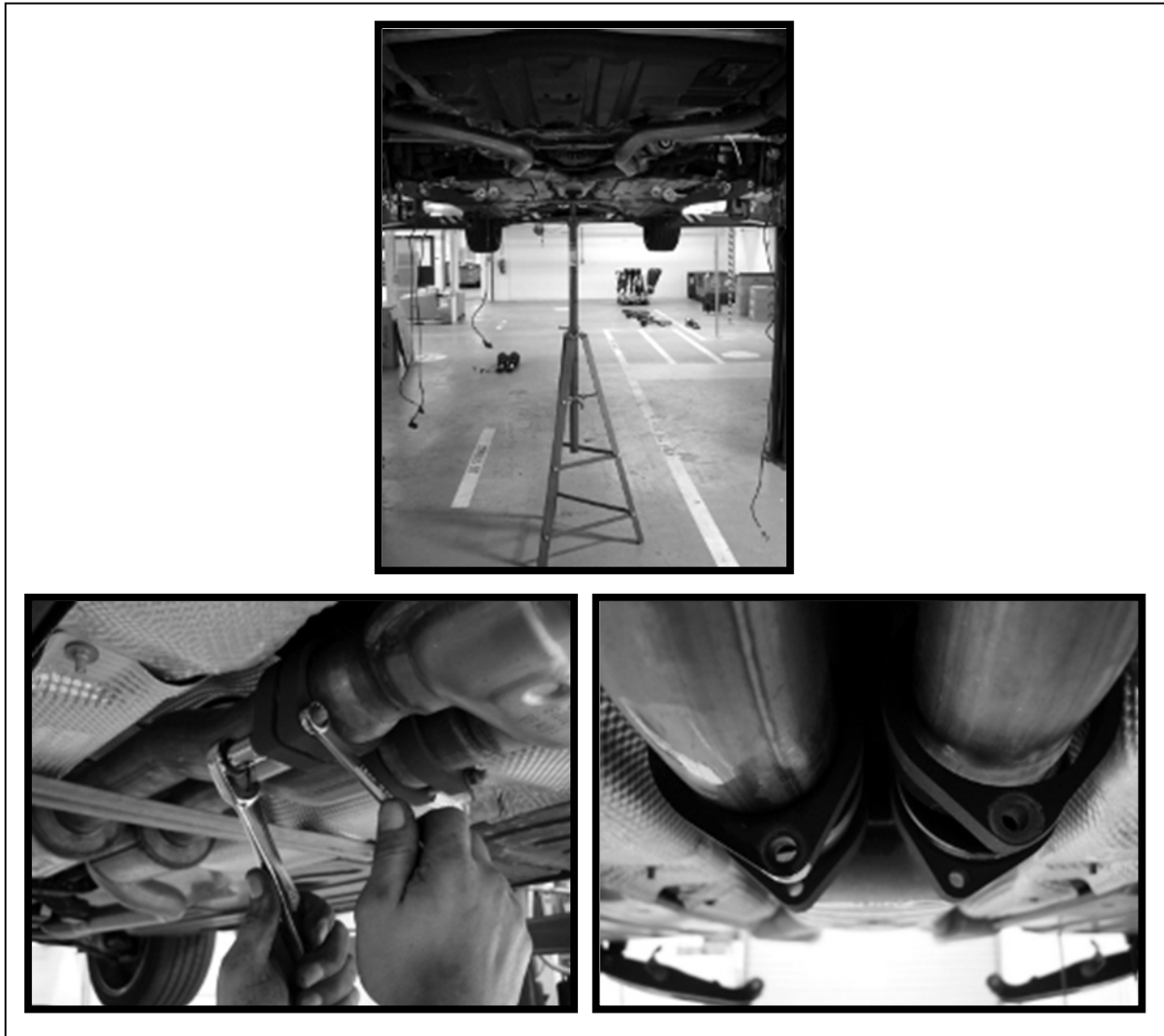

FIGURE 10-10



14.0 SUPPORT EXHAUST WHILE REMOVING RUBBER HANGERS, AND REMOVE EXHAUST. (FIGURE 10-11)

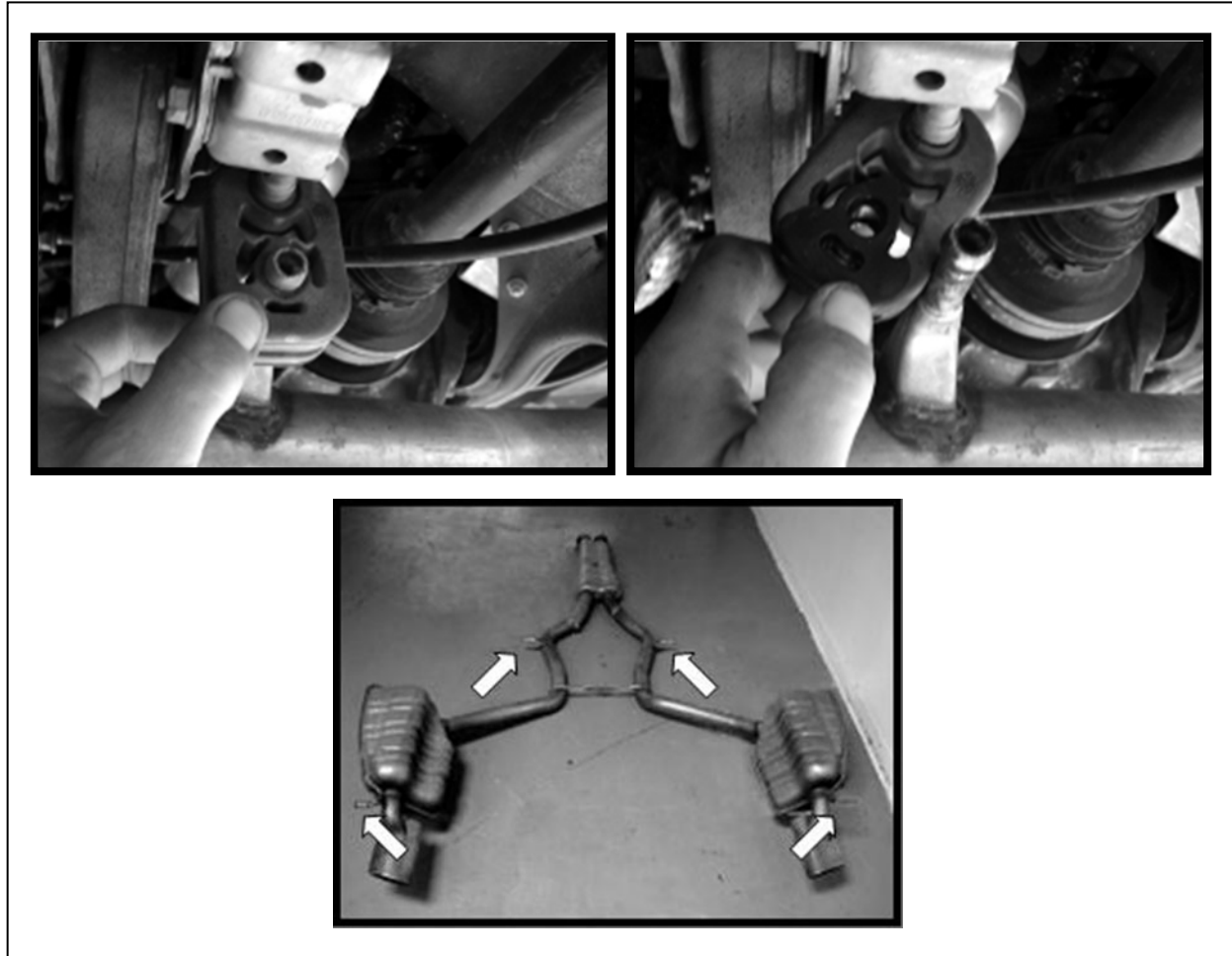

FIGURE 10-11



15.0 EXHAUST REMOVED. (FIGURE 10-12)

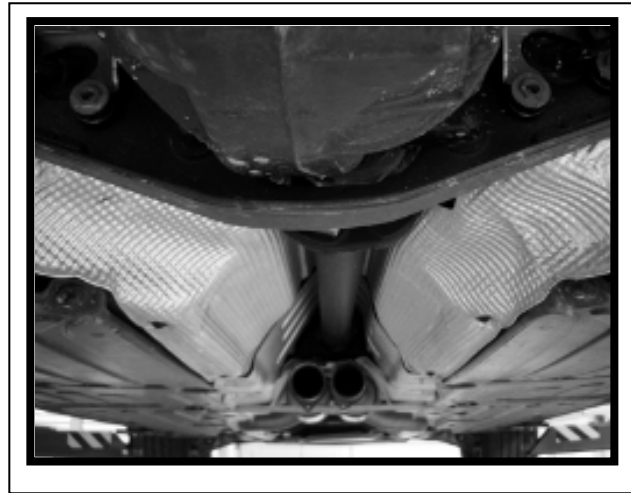

FIGURE 10-12

16.0 REMOVE DRIVESHAFT SAFETY BAR. (FIGURE 10-13)

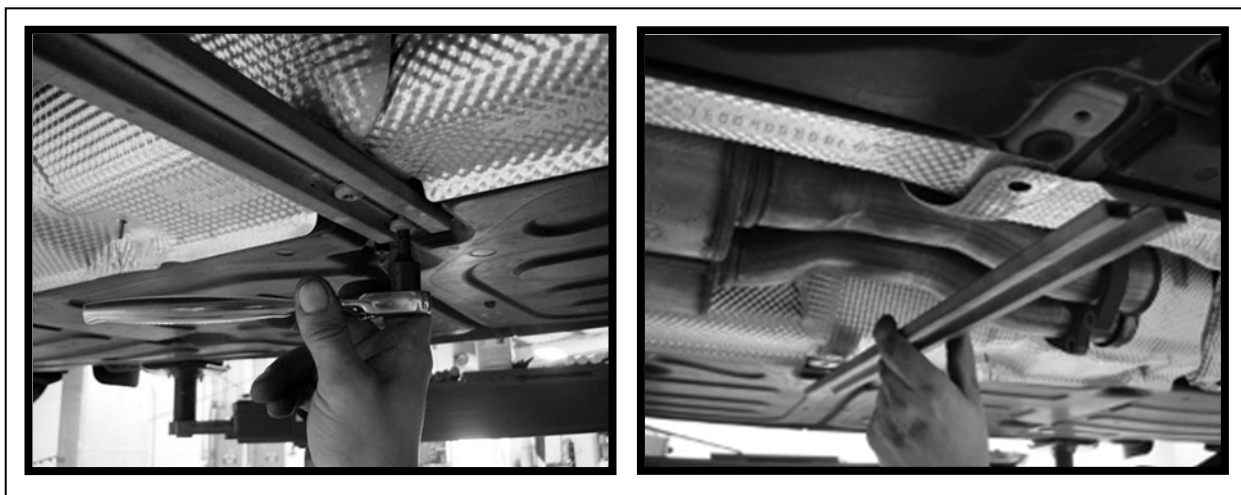

FIGURE 10-13



17.0 REMOVE TWO BOLTS HOLDING DRIVESHAFT BLOCK, AND REMOVE PILLOW BLOCK. (FIGURE 10-14)

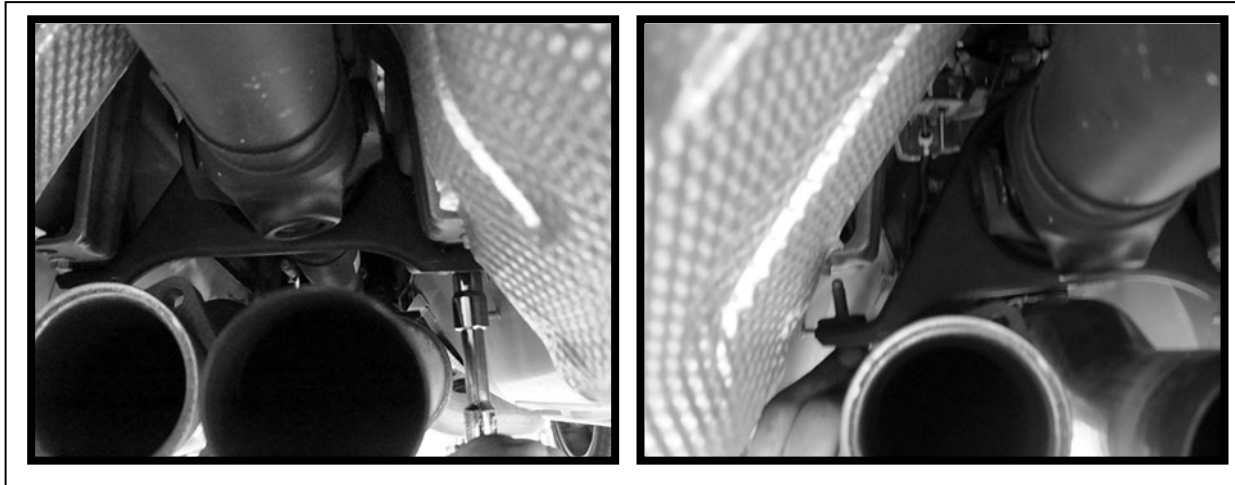

FIGURE 10-14

18.0 REMOVE REAR DRIVESHAFT BOLTS. (FIGURE 10-15)

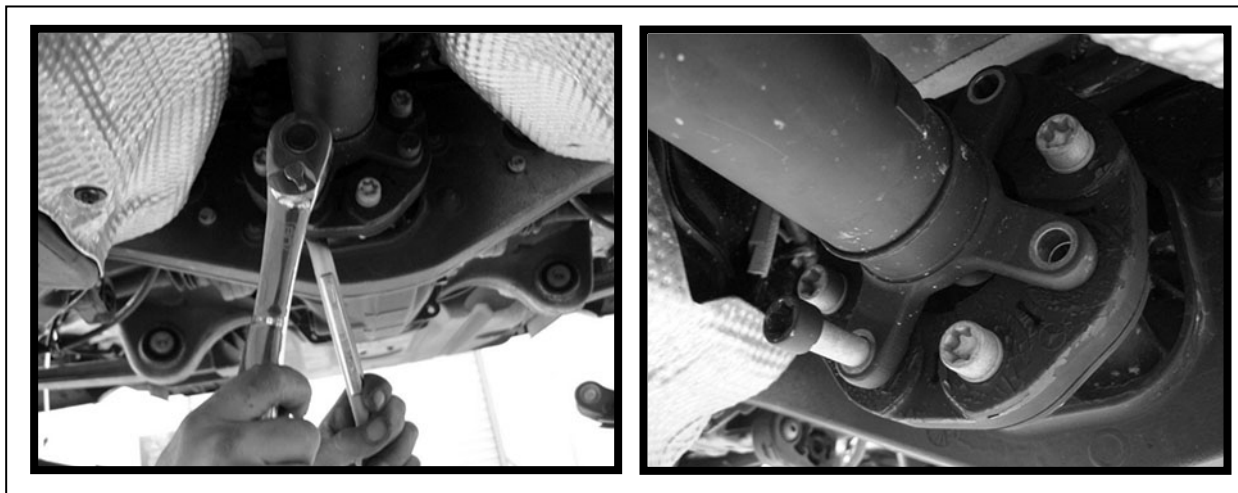

FIGURE 10-15



19.0 SLIDE DRIVESHAFT TOWARD FRONT OF VEHICLE AND REMOVE.
(FIGURE 10-16)

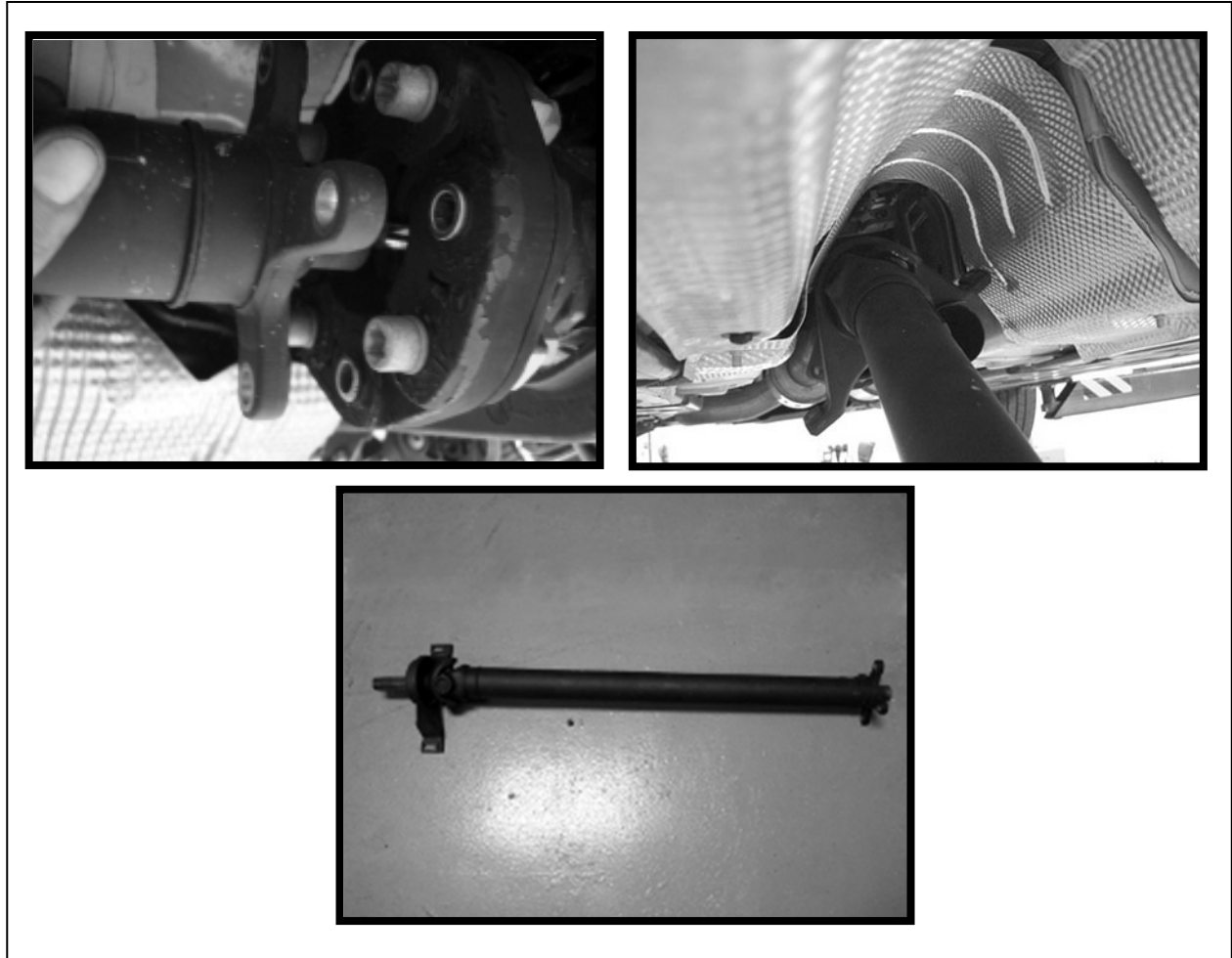

FIGURE 10-16



20.0 LOOSEN BOLTS AND REMOVE HEAT SHIELD. (FIGURE 10-17)

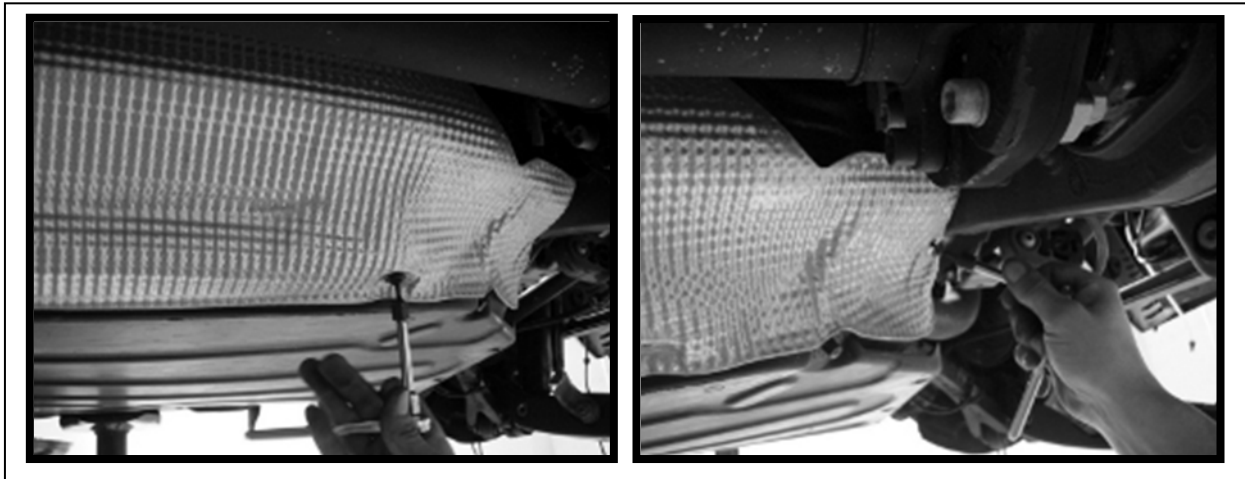

FIGURE 10-17

21.0 REMOVE BOLTS FROM ROCK GUARD. (FIGURE 10-18)

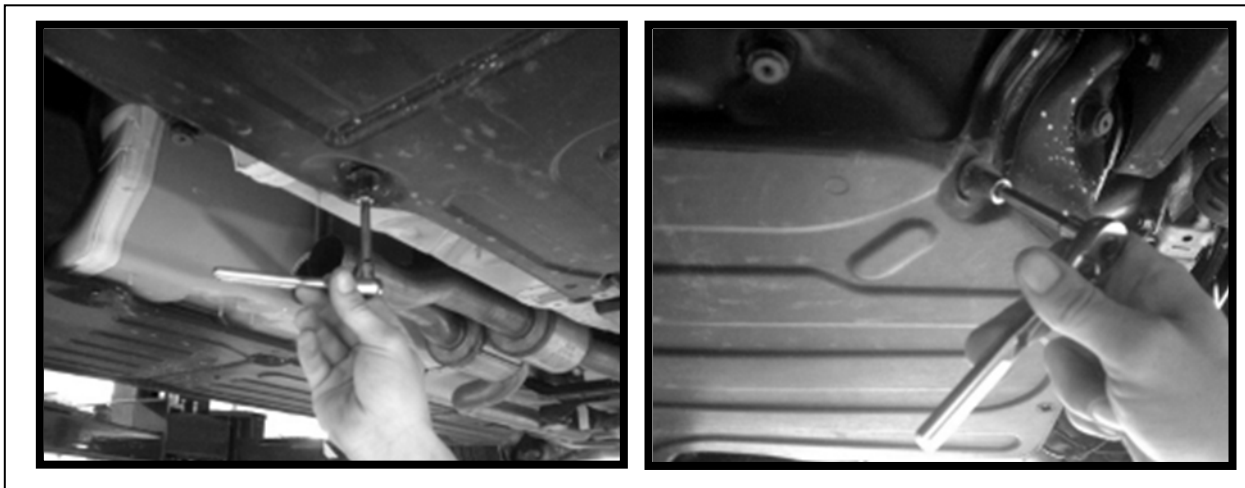

FIGURE 10-18



22.0 REMOVE ROCK GUARD. (FIGURE 10-19)

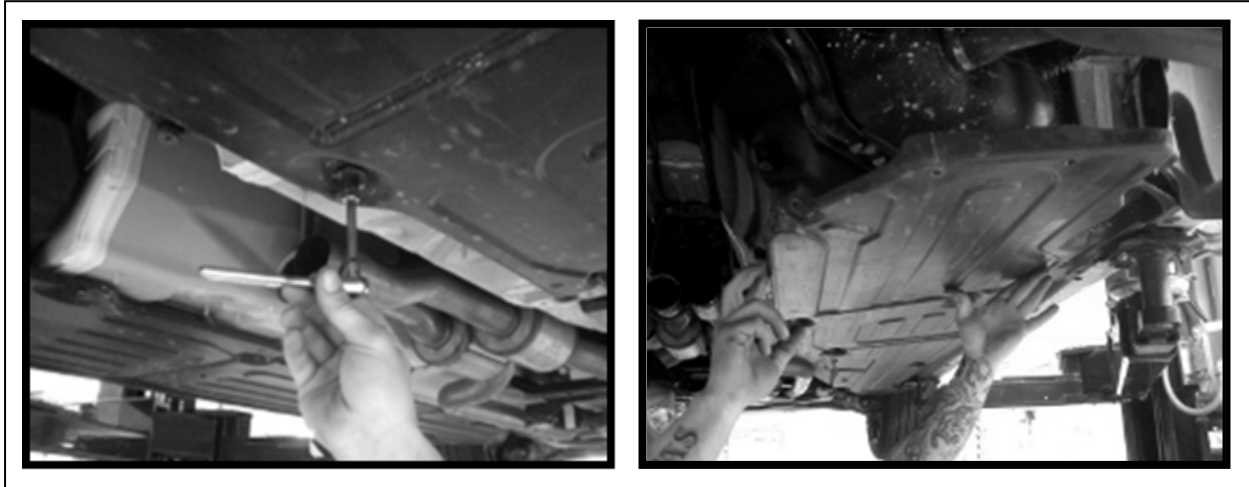

FIGURE 10-19

23.0 REMOVE CALIPER CLIP, AND REMOVE BOLT FROM BRAKE SENSOR.
(FIGURE 10-20)

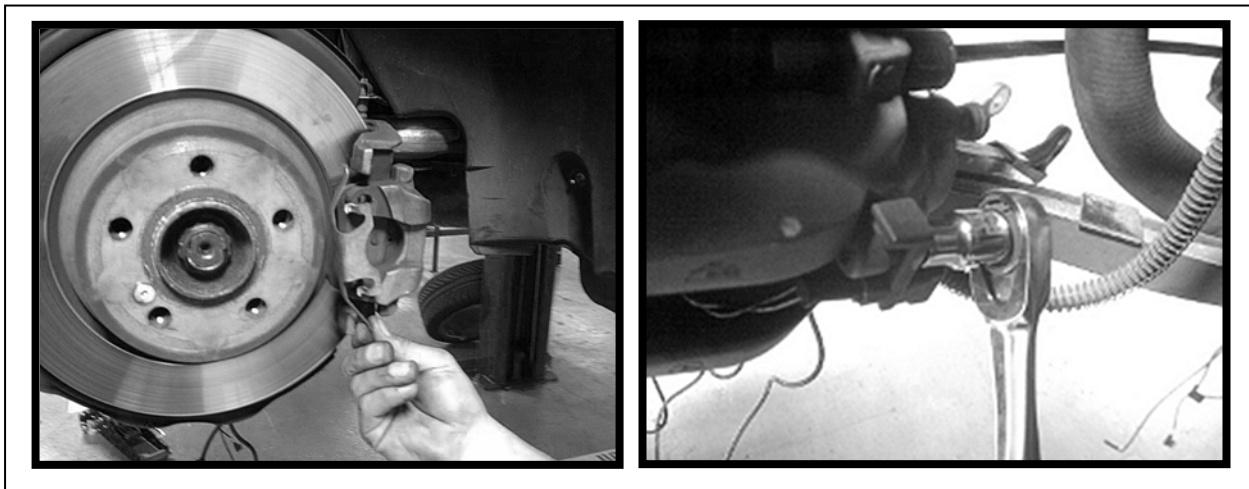

FIGURE 10-20



24.0 UNPLUG BRAKE SENSOR CABLE. (FIGURE 10-21)

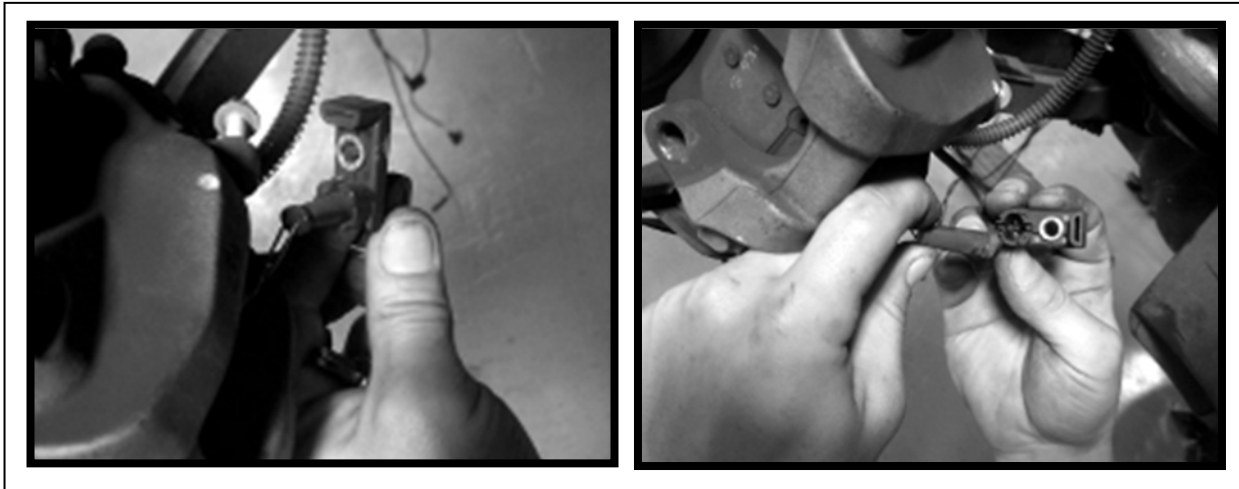

FIGURE 10-21

25.0 REMOVE CAP FROM CALIPER MOUNTING BOLT, LOOSEN BOLT.
(FIGURE 10-22)

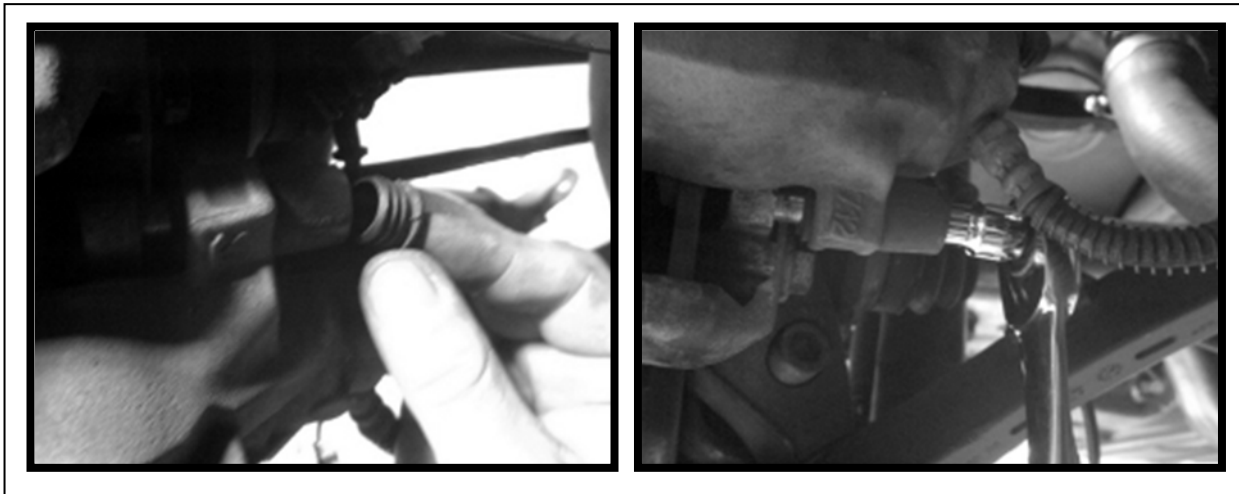

FIGURE 10-22



26.0 REMOVE CALIPER, AND SUSPEND WITH ZIP TIES. (FIGURE 10-23)

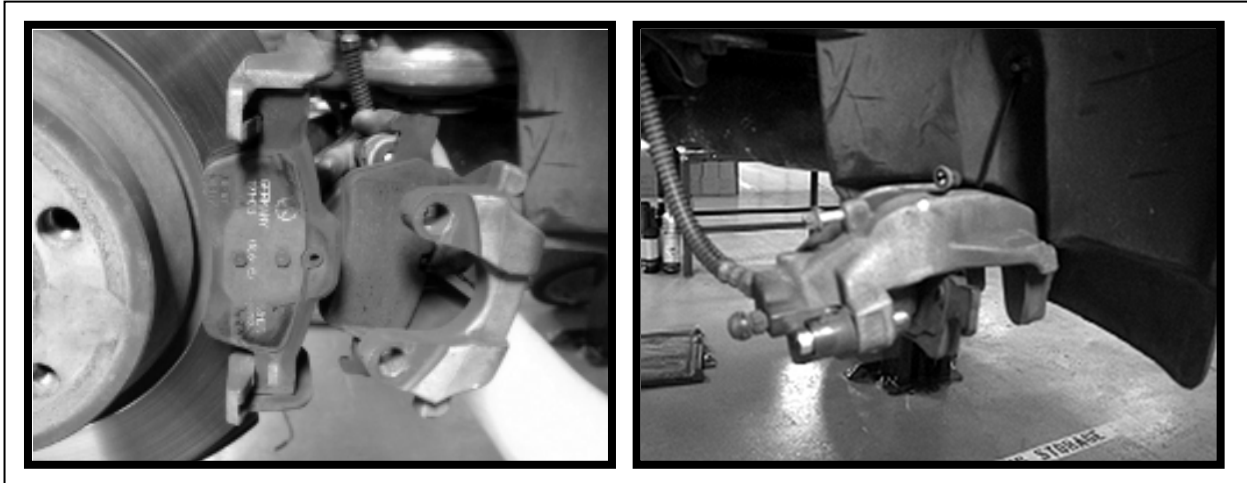

FIGURE 10-23



CAUTION! DRAIN FILLER HOSE OF GASOLINE!

27.0 LOOSEN FILLER NECK CLAMP, AND REMOVE FILLER HOSE.
(FIGURE 10-24)



FIGURE 10-24



28.0 THE REAR CROSSMEMBER BOLT POINTS. (FIGURE 10-25)

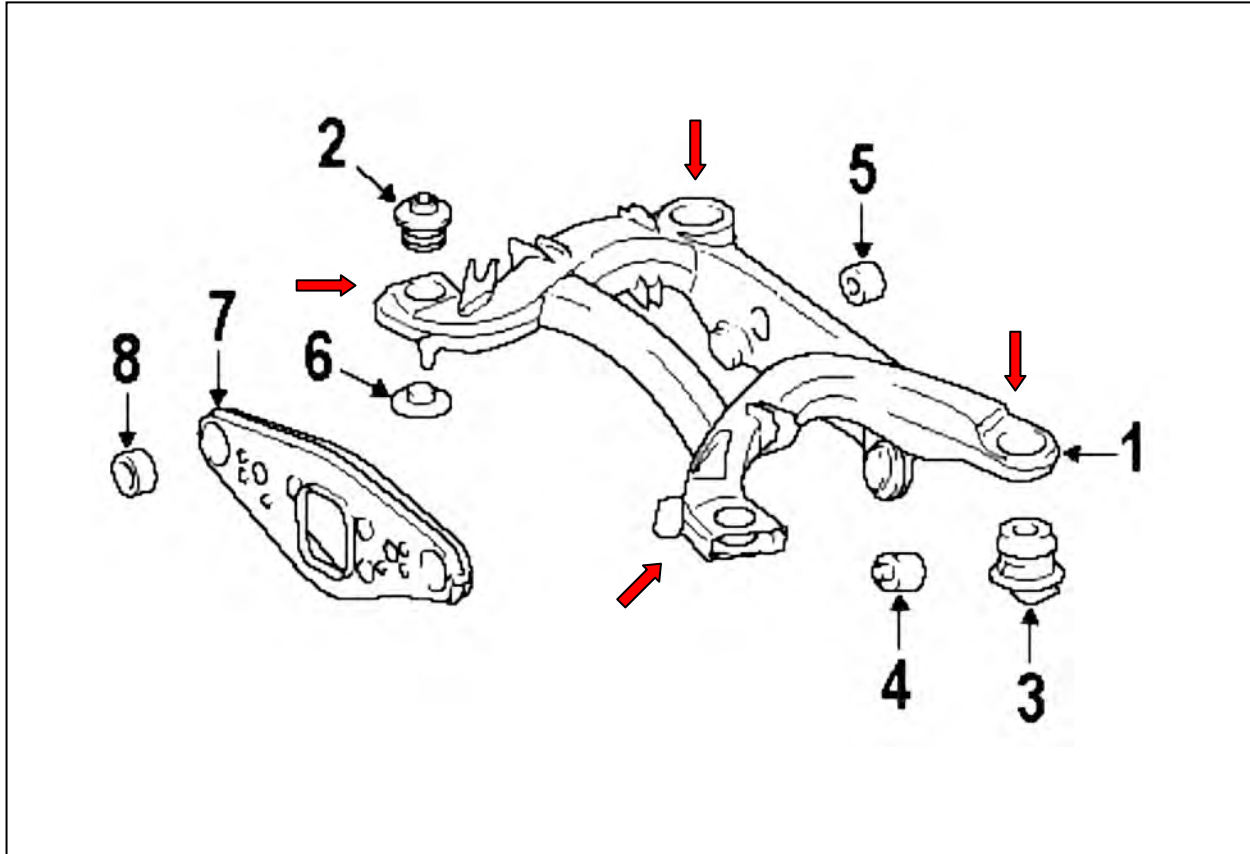

FIGURE 10-25



29.0 REMOVE THE (FOUR) REAR CROSSMEMBER MOUNTING BOLTS.
(FIGURE 10-26)

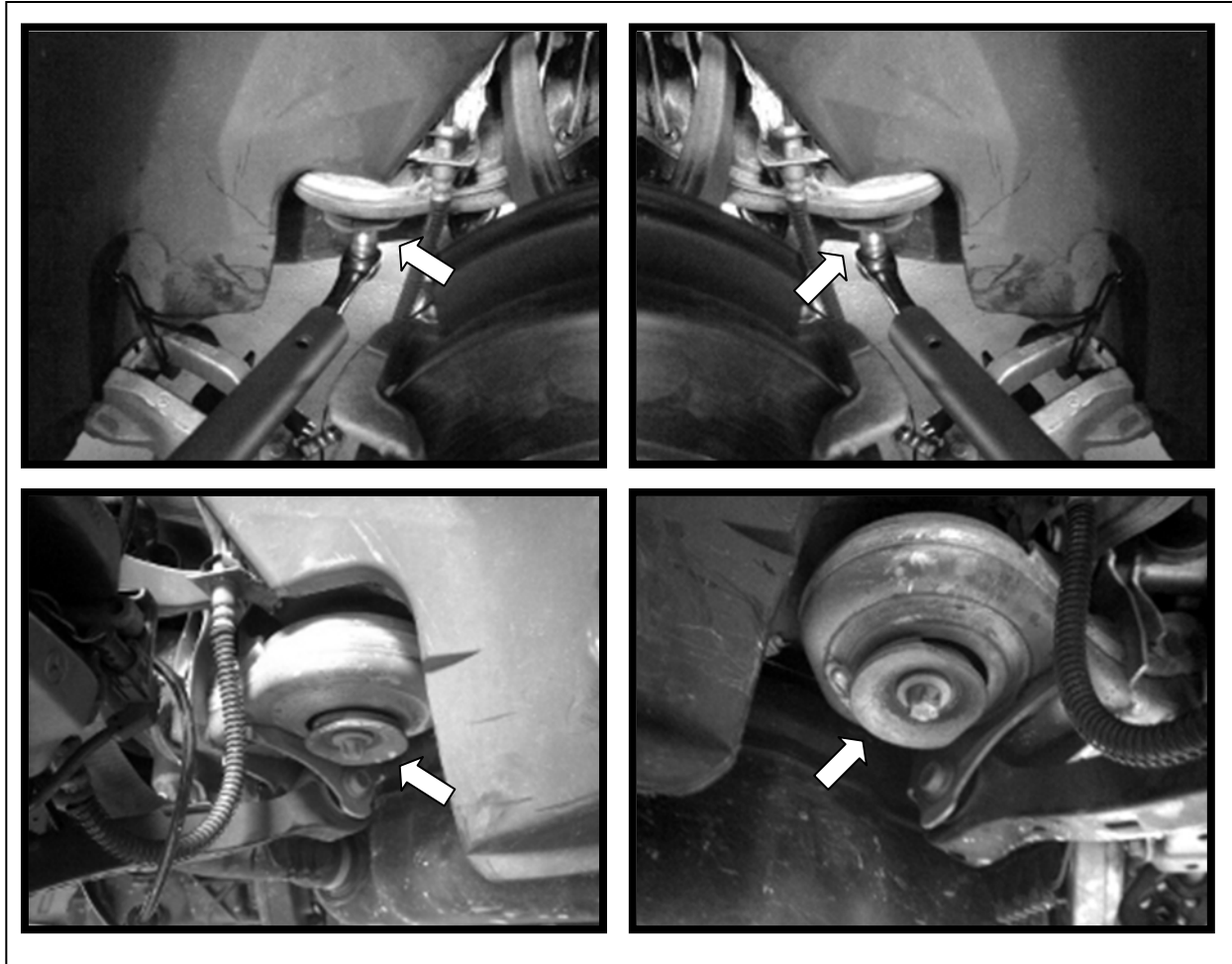

FIGURE 10-26



30.0 WITH VEHICLE ON LIFT, SUPPORT CROSSMEMBER ASSEMBLY ON STANDS, AND RAISE VEHICLE TO ACCESS SPRINGS. (FIGURE 10-27)

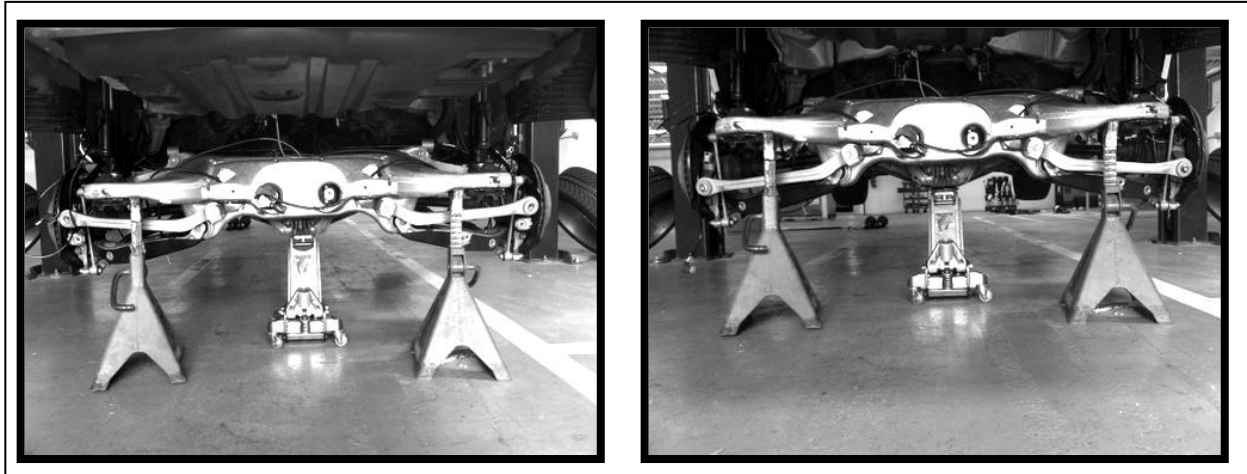

FIGURE 10-27



Use lifting platform (hoist) that is capable of raising the body separately from the wheels, lift body at the lifting points prescribed by the vehicle manufacturer. Vehicle slippage can cause danger to life and limb.



31.0 LOCATE, LOOSEN, AND REMOVE SWAYBAR BOLTS. (FIGURE 10-28)



FIGURE 10-28



32.0 RAISE SWAYBAR TOWARDS REAR OF VEHICLE. (FIGURE 10-29)



FIGURE 10-29

33.0 LOOSEN, AND REMOVE BOLTS FROM AIR RESEVOIR. (FIGURE 10-30)

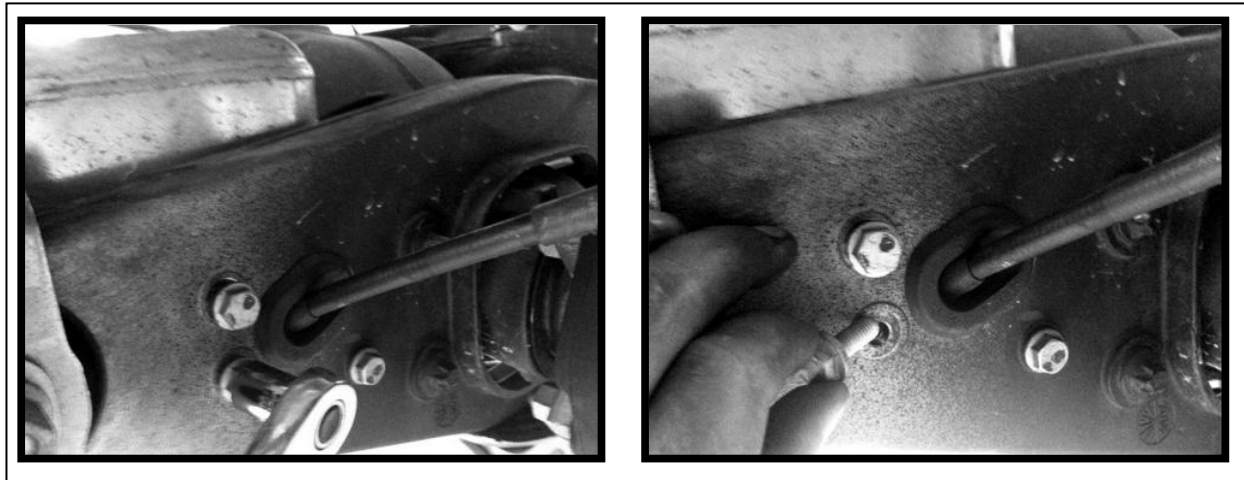

FIGURE 10-30



34.0 REMOVE OLD AIR SPRING AND RESIVIOR. (FIGURE 10-31)



FIGURE 10-31



35.0 REPLACE RETENTION CLIP WITH NEW CLIP PROVIDED ON THE UPPER MOUNT. (FIGURE 10-32)

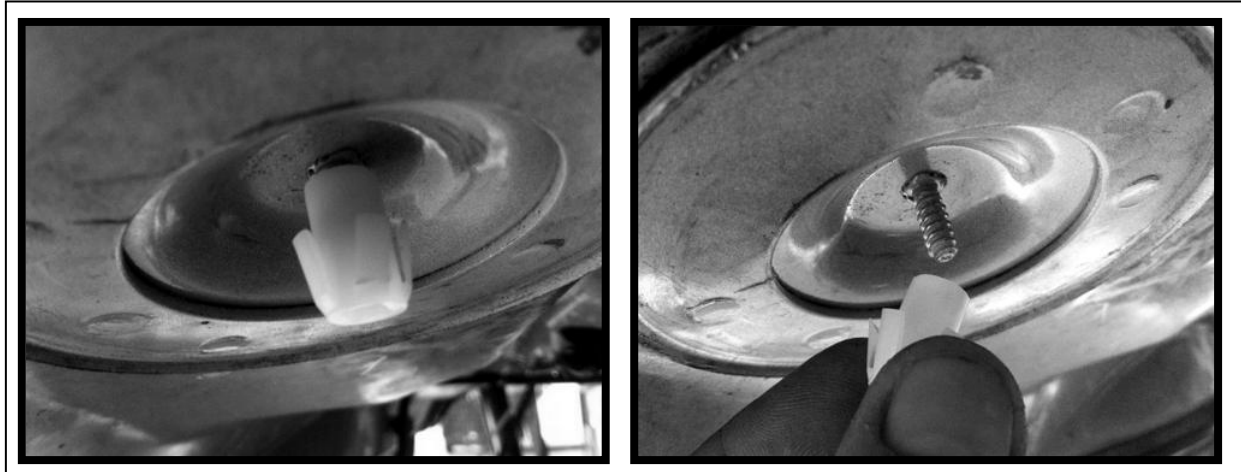

FIGURE 10-32

36.0 WITH THE AIR SPRING REMOVED FROM THE VEHICLE, REMOVE THE AIR LINE FROM AIR SPRING. (FIGURE 10-33)

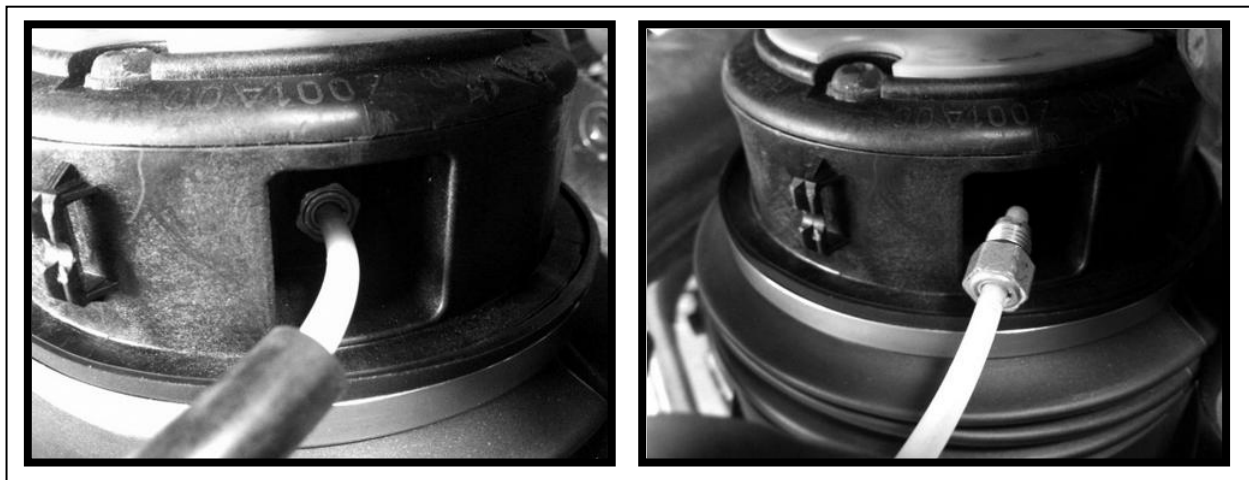

FIGURE 10-33



REAR SPRING INSTALLATION:



Torque nuts and bolts to the manufactures specification.

- 1.0 LOWER SWAY BAR INTO POSITION > TIGHTEN BOLTS
- 2.0 LOWER CAR ONTO CROSSMEMBER ASSEMBLY > TIGHTEN MOUNTING BOLTS X4
- 3.0 PLUG IN SAS AIR RIDE ELECTRICAL PLUG
- 4.0 ATTACH FUEL TANK FILLER HOSE > TIGHTEN CLAMP
- 5.0 INSTALL ROCK GUARD
- 6.0 RE-INSTALL THE REAR BRAKE CALIPER.
 - 6.1 INSTALL CALIPER, TIGHTEN THE BOLT ON THE BACKSIDE OF THE CALIPER
 - 6.2 RE-CONNECT THE SENSOR CONNECTOR > RE-INSTALL THE SENSOR BRACKET BOLT
 - 6.3 INSTALL RETAINING CLIP
- 7.0 INSTALL HEAT SHIELD
- 8.0 INSTALL DRIVESHAFT
- 9.0 INSTALL DRIVESHAFT BLOCK
- 10.0 INSTALL DRIVESHAFT SAFETY BAR
- 11.0 INSTALL EXHAUST
- 12.0 INSTALL SENSOR LINES IN BRACKETS
- 13.0 PLUG IN SENSOR CONNECTORS
- 14.0 INSTALL PUSH PINS AND BOLTS IN FENDER
- 15.0 PLUG IN AIR RIDE WIRING
- 16.0 INSTALL AIR LINES TO METER BLOCK
- 17.0 INSTALL METER BLOCK
- 18.0 ALIGN LOGO AND AIR FITTING OUTBOARD, TOWARDS WHEEL (FIGURE 10-34)

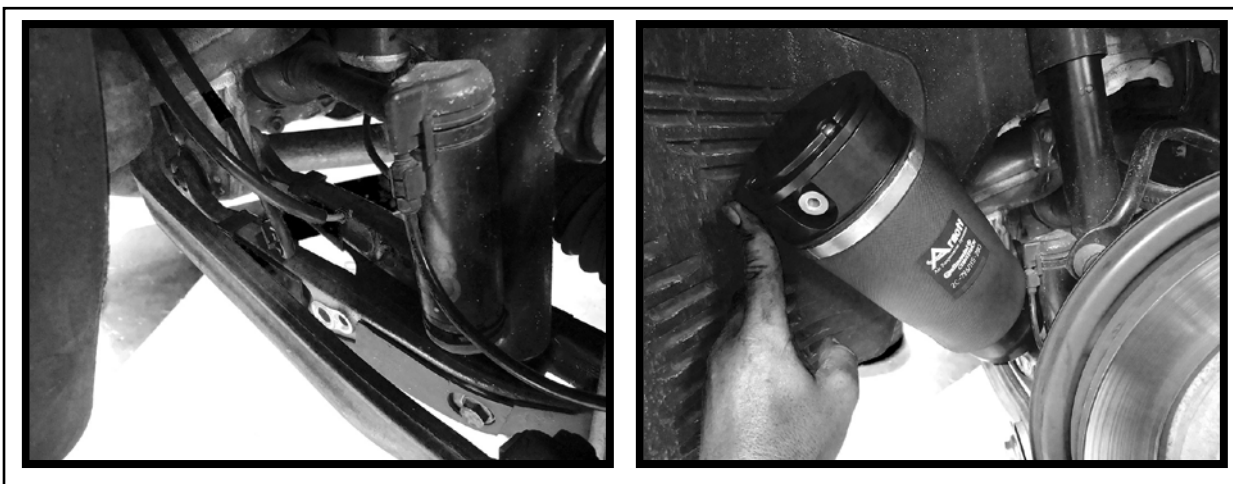

FIGURE 10-34



19.0 COMPRESS AIR SPRING TO INSTALL. (FIGURE 10-35)

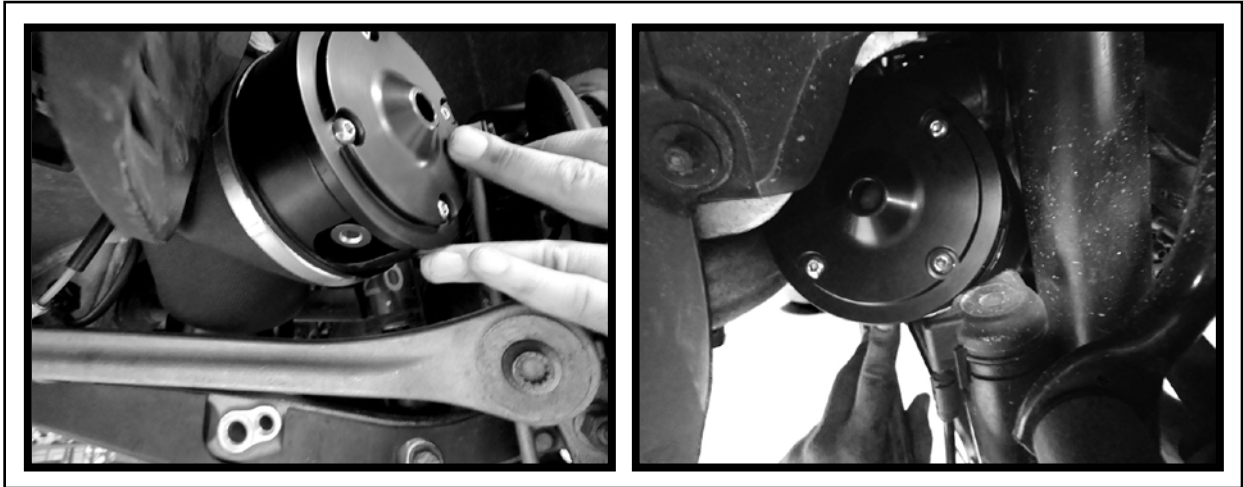

FIGURE 10-35

20.0 LINE UP MOUNT TO LOWER CONTROL ARM. (FIGURE 10-36)

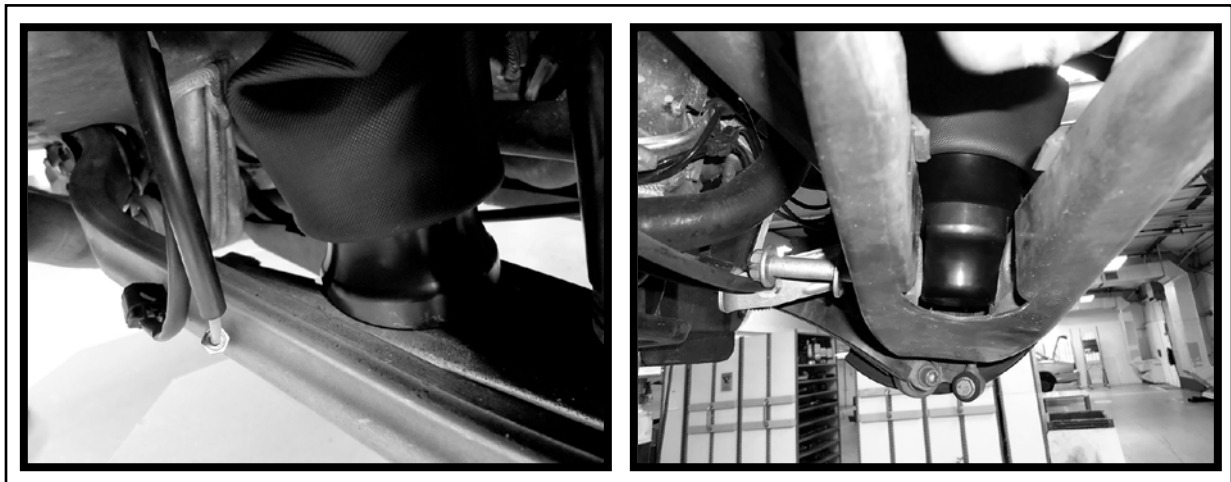

FIGURE 10-36



21.0 INSTALL, AND TIGHTEN MOUNTING BOLT. (FIGURE 10-37)

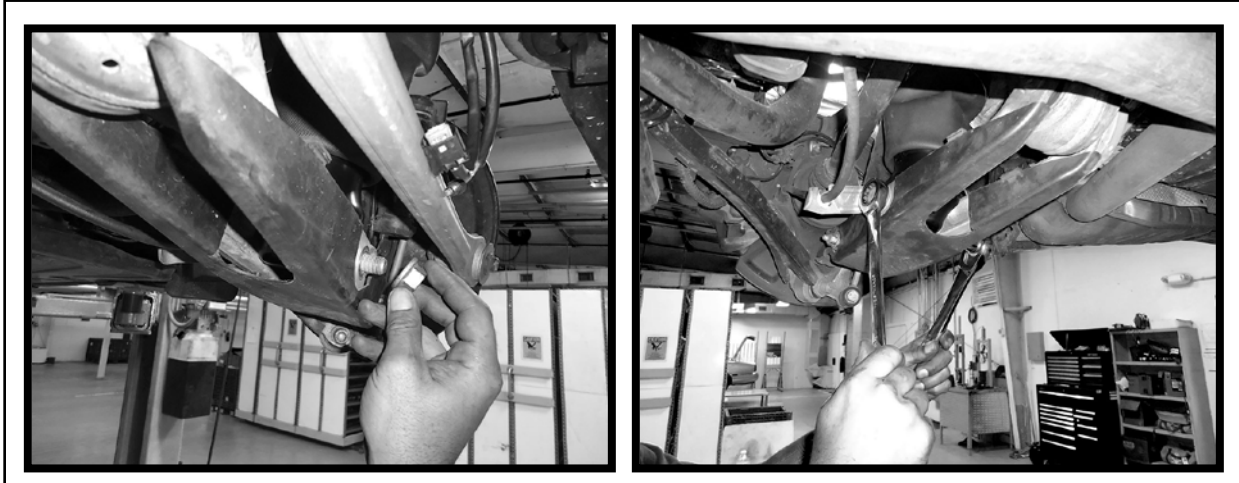

FIGURE 10-37

22.0 ENGAGE TOP CLIP, AND INSTALL AIR LINE. (FIGURE 10-38)



FIGURE 10-38



23.0 CONNECT AIR SPRING VALVE WIRING. (FIGURE 10-39)



FIGURE 10-39

- 24.0 INSTALL REAR TIRE; TIGHTEN LUG NUTS TO MANUFACTURERS' SPECIFICATION.
- 25.0 REMOVE JACK STANDS > LOWER VEHICLE TO STANDARD VEHICLE FROM THE LIFTING PLATFORM.
- 25.0 LOWER VEHICLE TO STANDARD VEHICLE HEIGHT FROM THE LIFTING PLATFORM.
- 27.0 RE-CONNECT BATTERY TERMINAL.



Never under any circumstances allow the vehicle to be fully lowered from the lifting platform (hoist) with the air suspension depressurized.

- 28.0 START ENGINE, WAIT 2 MINUTES, OPERATE THE RAISING FUNCTION OF THE CARS ELECTRONICS.
- 29.0 INITIALLY LOWER LIFTING PLATFORM SLOWLY AND ONLY COMPLETELY WHEN THE VEHICLE RISES OF ITS OWN ACCORD.
- 30.0 CHECK SHOCK FOR LEAKS.
- 31.0 INSTALLATION COMPLETE.



VERY IMPORTANT!!

THESE AIR SPRINGS CONTAINS A SOLENOID VALVE. ONCE INFLATED; ONLY THE "MERCEDES DAS STAR" DIAGNOSTIC COMPUTER CAN DEFLATE THE AIR SPRINGS.